



TOW TRUCK EQUIPMENT



Your
is our **SUCCESS**

www.toracompany.com



HYDRAULIC WINCH PACKAGE

8K-77K Pulling Capacity Range
Hydraulic Winches

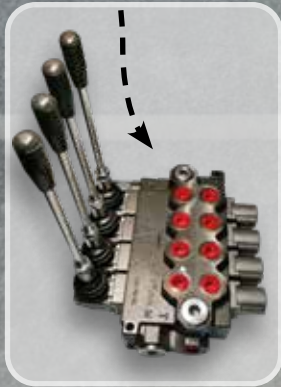

1-40 GPM
Displacement
Range Monoblock &
Sectional Valves



1-40 GPM
Displacement Range
Hydraulic Pumps



Allison, Fuller, Detro
Volvo, ZF
Power Take OFF's

Your
is our **SUCCESS**



THW SERIES HYDRAULIC WINCHES FEATURES

- ▶ High-strength, long-lasting steel body
- ▶ Extra reinforced planetary gear system with special steel heat treatment
- ▶ Lightweight and powerful design
- ▶ 100% negative effective hydraulic disc brake system
- ▶ Standard winch guide system and rope stabiliser
- ▶ Manual winch discharge system provided as standard
- ▶ High torque hydromotor



THW-8K

Optional Pneumatic Rope Release

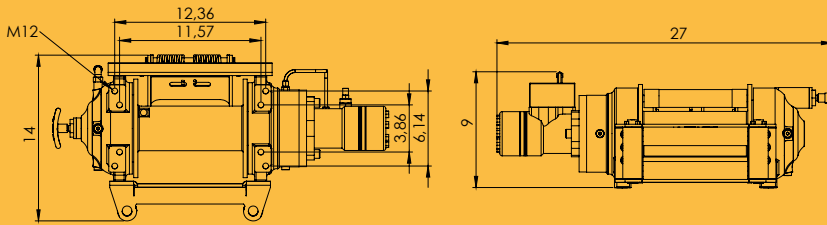

Rope Winding Count	Pulling Capacity lbs	Winding Speed (ft-min)	Rope Length ft
1	8000	58	22
2	6700	64	47
3	5776	71	74
4	5070	77	103
5	4523	83	134

Maximum Pulling Force	: 8000 lbs
Maximum Rope Diameter	: 25/64"
Maximum Rope Length	: 134 ft
Hydromotor	: 12 in ³
Maximum Pump Flow	: 15.8 gpm
Gear Ratio	: 5/1
Maximum Operating Pressure	: 1740 psi
Recommended Gear Oil Product	: 80w 90 - 23.6 fl oz
Weight	: 138 lbs



THW-10K

Optional Pneumatic Rope Release

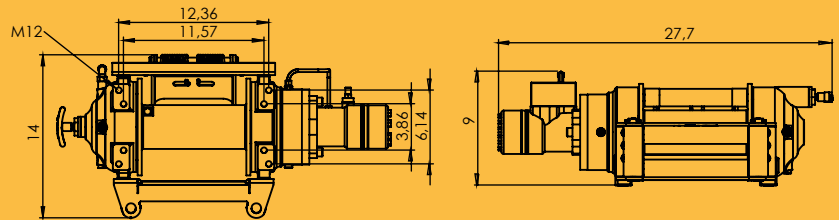

Rope Winding Count	Pulling Capacity lbs	Winding Speed ft-min	Rope Length ft
1	10000	47	22
2	8370	52	47
3	7215	57	74
4	6342	62	103
5	5657	66	134

Maximum Pulling Force	: 10000 lbs
Maximum Rope Diameter	: 25/64"
Maximum Rope Length	: 134 ft
Hydromotor	: 15 in ³
Maximum Pump Flow	: 15.8 gpm
Gear Ratio	: 5/1
Maximum Operating Pressure	: 2030 psi
Recommended Gear Oil Product	: 80w 90 - 23.6 fl oz
Weight	: 141 lbs



THW-12K

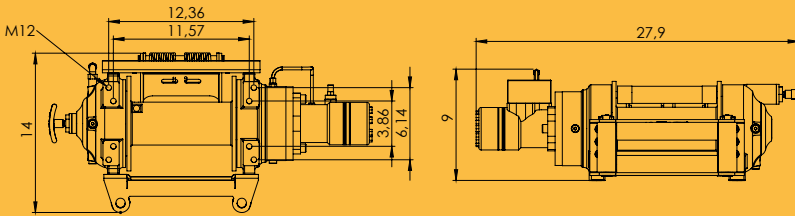

Rope Winding Count	Pulling Capacity lbs	Winding Speed ft-min	Rope Length ft
1	12000	37	19
2	9920	41	40
3	8510	46	63
4	7360	50	88
5	6494	55	116

Maximum Pulling Force	: 12000 lbs
Maximum Rope Diameter	: 15/32"
Maximum Rope Length	: 116 ft
Hydromotor	: 19.2 in ³
Maximum Pump Flow	: 15.8 gpm
Gear Ratio	: 5/1
Maximum Operating Pressure	: 1885 psi
Recommended Gear Oil Product	: 80w 90 - 23.6 fl oz
Weight	: 143 lbs



THW-15K

Optional Pneumatic Rope Release

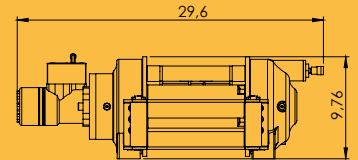
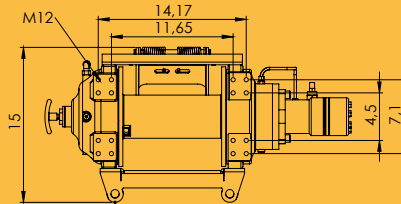

Rope Winding Count	Pulling Capacity lbs	Winding Speed ft-min	Rope Length ft
1	15000	34	22
2	12425	38	48
3	10,617	41	75
4	9268	45	106
5	8223	49	139
6	7392	53	173

Maximum Pulling Force	: 15000 lbs
Maximum Rope Diameter	: 15/32"
Maximum Rope Length	: 173 ft
Hydromotor	: 19 in ³
Maximum Pump Flow	: 15.8 gpm
Gear Ratio	: 6/1
Maximum Operating Pressure	: 2248 psi
Recommended Gear Oil Product	: 80w 90 - 27 fl oz
Weight	: 180 lbs



THW-16K

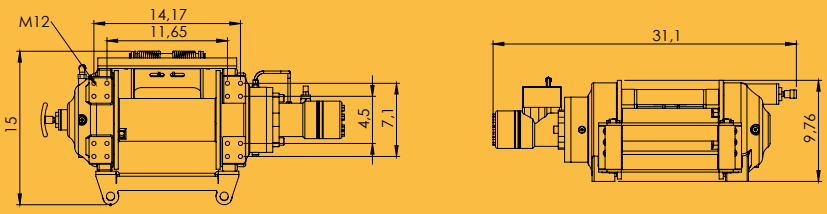

Rope Winding Count	Pulling Capacity lbs	Winding Speed ft-min	Rope Length ft
1	16000	34	19
2	12967	38	41
3	10893	43	66
4	9389	47	94
5	8251	52	131

Maximum Pulling Force	: 16000 lbs
Maximum Rope Diameter	: 35/64"
Maximum Rope Length	: 131 ft
Hydromotor	: 19 in ³
Maximum Pump Flow	: 15.8 gpm
Gear Ratio	: 6/1
Maximum Operating Pressure	: 2393 psi
Recommended Gear Oil Product	: 80w 90 - 27 fl oz
Weight	: 185 lbs



THW-18K

Optional Mechanic Rope Release

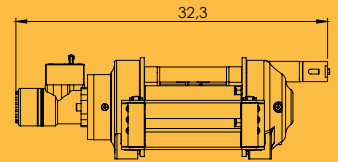
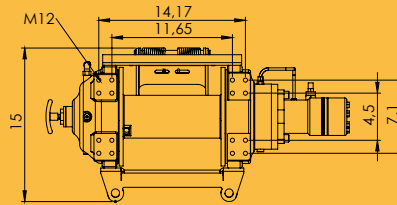

Rope Winding Count	Pulling Capacity lbs	Winding Speed ft-min	Rope Length ft
1	18000	27	19
2	14645	31	41
3	12301	35	66
4	10604	38	94
5	9318	41	131

Maximum Pulling Force	: 18000 lbs
Maximum Rope Diameter	: 35/64"
Maximum Rope Length	: 131 ft
Hydromotor	: 24 in ³
Maximum Pump Flow	: 15.8 gpm
Gear Ratio	: 6/1
Maximum Operating Pressure	: 2175 psi
Recommended Gear Oil Product	: 80w 90 - 27 fl oz
Weight	: 187 lbs



THW-22K

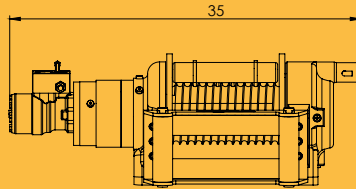
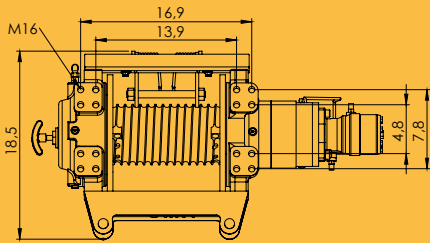

Rope Winding Count	Pulling Capacity lbs	Winding Speed ft-min	Rope Length ft
1	22000	25	19
2	18346	28	43
3	15628	31	72
4	13611	34	105
5	12054	37	141

Maximum Pulling Force	: 22000 lbs
Maximum Rope Diameter	: 5/8"
Maximum Rope Length	: 141 ft
Hydromotor	: 10 in ³
Maximum Pump Flow	: 15.8 gpm
Gear Ratio	: 21/1
Maximum Operating Pressure	: 2346 psi
Recommended Gear Oil Product	: 80w 90 - 34 fl oz
Weight	: 330 lbs



THW-26K

Optional Mechanic Rope Release

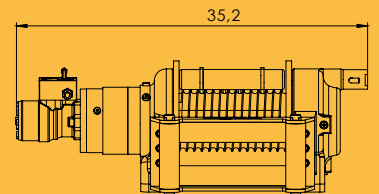
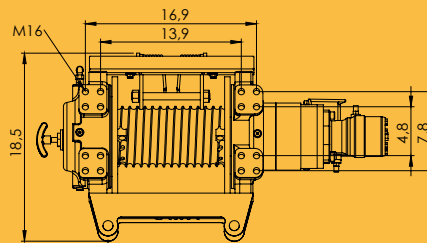

Rope Winding Count	Pulling Capacity lbs	Winding Speed ft-min	Rope Length ft
1	26500	20	19
2	21841	22	43
3	18607	25	72
4	16203	27	105
5	14352	30	141

Maximum Pulling Force	: 26500 lbs
Maximum Rope Diameter	: 5/8"
Maximum Rope Length	: 141 ft
Hydromotor	: 12 in ³
Maximum Pump Flow	: 15.8 gpm
Gear Ratio	: 21/1
Maximum Operating Pressure	: 2320 psi
Recommended Gear Oil Product	: 80w 90 - 34 fl oz
Weight	: 341 lbs



THW-33K

Optional Pneumatic Rope Release

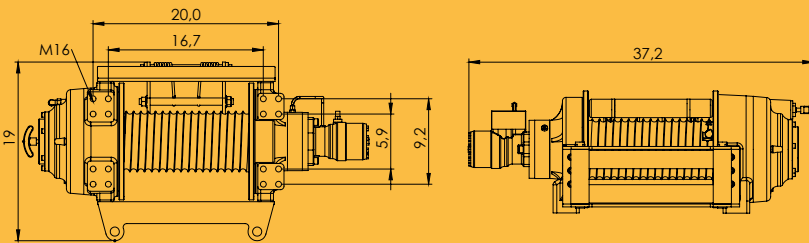

Rope Winding Count	Pulling Capacity lbs	Winding Speed ft-min	Rope Length ft
1	33000	16	24
2	27844	18	55
3	23682	20	91
4	20593	22	137

Maximum Pulling Force	: 33000 lbs
Maximum Rope Diameter	: 45/64"
Maximum Rope Length	: 137 ft
Hydromotor	: 10 in ³
Maximum Pump Flow	: 15.8 gpm
Gear Ratio	: 36/1
Maximum Operating Pressure	: 2393 psi
Recommended Gear Oil Product	: 80w 90 - 68 fl oz
Weight	: 429 lbs



THW-40K

Optional Pneumatic Rope Release

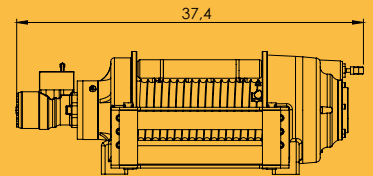
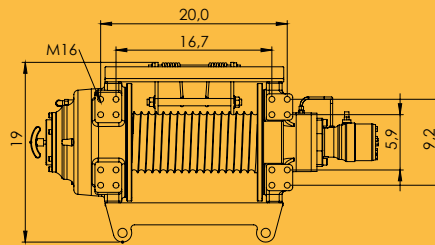

Rope Winding Count	Pulling Capacity lbs	Winding Speed ft-min	Rope Length ft
1	40000	14	24
2	32716	15	55
3	27809	17	91
4	14180	19	137

Maximum Pulling Force	: 40000 lbs
Maximum Rope Diameter	: 45/64"
Maximum Rope Length	: 137 ft
Hydromotor	: 12 in ³
Maximum Pump Flow	: 15.8 gpm
Gear Ratio	: 36/1
Maximum Operating Pressure	: 2393 psi
Recommended Gear Oil Product	: 80w 90 - 68 fl oz
Weight	: 441 lbs



THW-66K

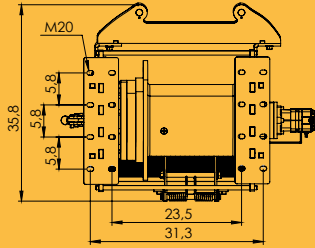
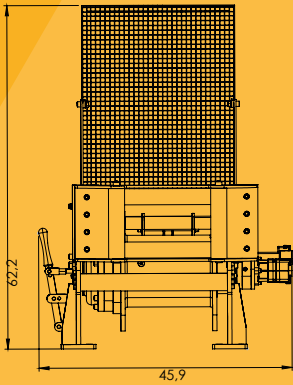

Rope Winding Count	Pulling Capacity lbs	Winding Speed ft-min	Rope Length ft
1	66000	11	54
2	58047	12	113
3	51482	14	175
4	45252	16	242

Maximum Pulling Force	: 66000 lbs
Maximum Rope Diameter	: 1,02"
Maximum Rope Length	: 242 ft
Hydromotor	: 9,6 in ³
Maximum Pump Flow	: 19.8 gpm
Gear Ratio	: 150/1
Maximum Operating Pressure	: 2393 psi
Recommended Gear Oil Product	: 80w 90 - 135 fl oz
Weight	: 1069 lbs



THW-77K

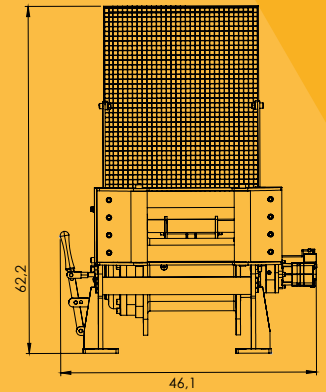
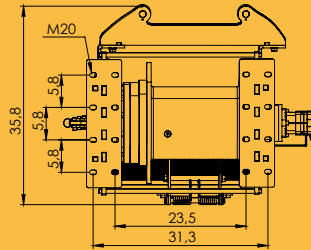

Rope Winding Count	Pulling Capacity lbs	Winding Speed ft-min	Rope Length ft
1	77000	8	50
2	67170	9	105
3	59167	10	166
4	52869	11	229

Maximum Pulling Force	: 77000 lbs
Maximum Rope Diameter	: 1,10"
Maximum Rope Length	: 229 ft
Hydromotor	: 12 in ³
Maximum Pump Flow	: 19.8 gpm
Gear Ratio	: 150/1
Maximum Operating Pressure	: 2248 psi
Recommended Gear Oil Product	: 80w 90 - 135 fl oz
Weight	: 1080 lbs



HW SERIES HYDRAULIC WINCHES FEATURES

- ▶ High-strength, long-lasting steel body
- ▶ Extra reinforced planetary gear system with special steel heat treatment
- ▶ Lightweight and powerful design
- ▶ Standard winch guide system and rope stabiliser
- ▶ Manual winch discharge system provided as standard
- ▶ High torque hydromotor

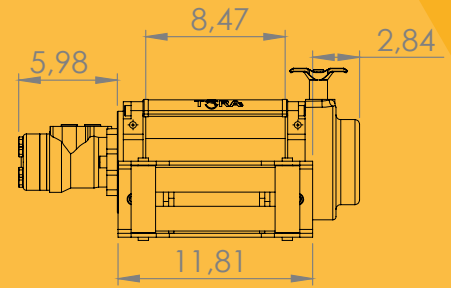
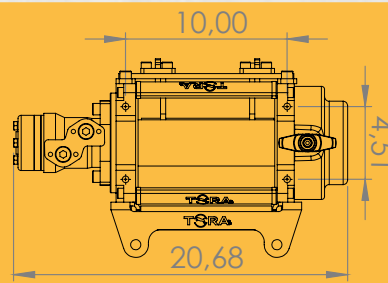

HW-10000

Rope Winding Count	Pulling Capacity lbs	Winding Speed ft-min	Rope Length ft
1	10000	17,3	16,4
2	8012	15	37
3	6683	8,9	61
4	5732	4,6	83,6

HW-12000

Rope Winding Count	Pulling Capacity lbs	Winding Speed ft-min	Rope Length ft
1	12000	17,3	16,4
2	10595	15	37
3	9485	8,9	61
4	7904	4,6	83,6



HW-15000

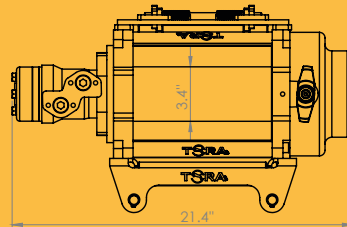
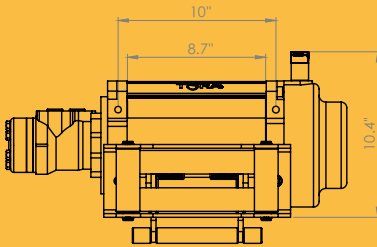

Rope Winding Count	Pulling Capacity lbs	Winding Speed ft-min	Rope Length ft
1	15000	19,7	18
2	12120	24,3	40,7
3	10168	28,9	65,9
4	8757	33,8	86,9

Maximum Pulling Force	: 15000 lbs
Motor Displacement	: 4,88 in ³
Oil Flow	: 1.3~15,85 gpm
Pressure	: 1885 psi
Rope	: 82 ft x Ø 15/32"
Fairlead	: 4-ways rollers
Net Weight	: 152 lbs



ISO 9001
ISO 14001





-  www.toracompany.com
-  info@toracompany.com
-  11417 IL 19, Franklin Park, IL 60131
-  (630) 785-2410
-  (331) 688-4947



[toracompany](https://www.facebook.com/toracompany)



[tora.company](https://www.instagram.com/tora.company)



www.toracompany.com

Your
is our **SUCCESS**

www.toracompany.com