

THW-18K

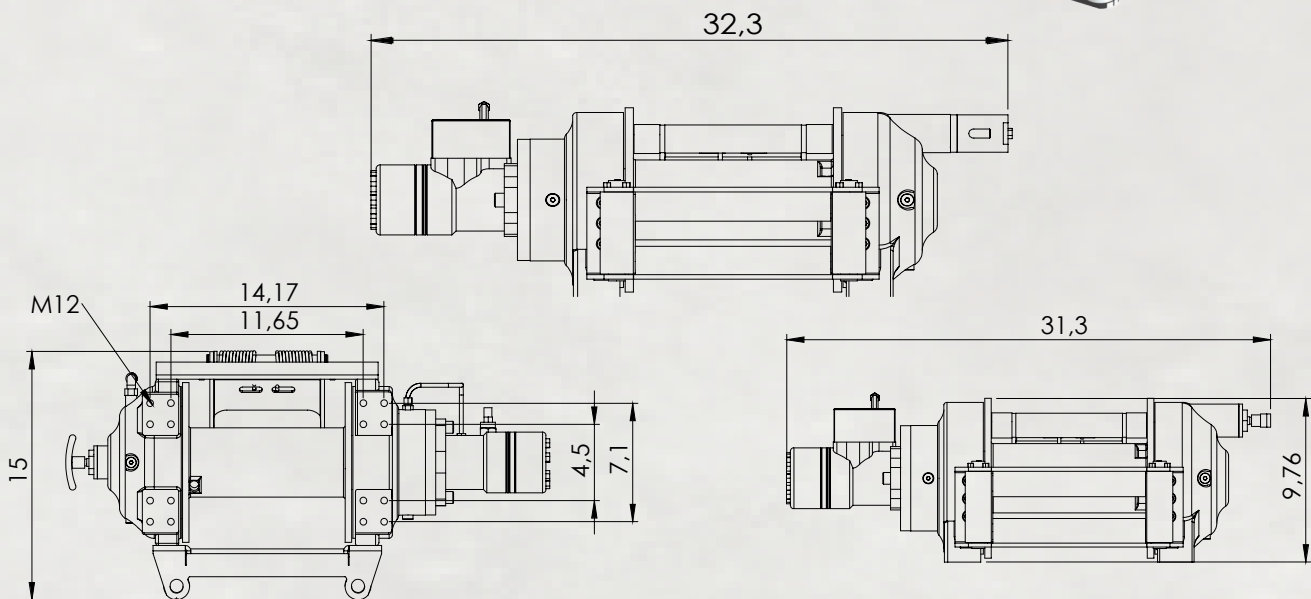
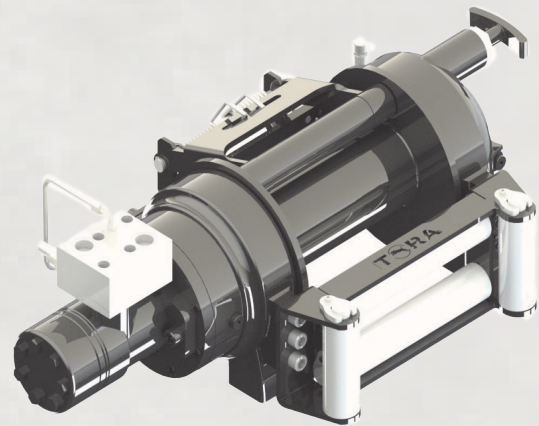
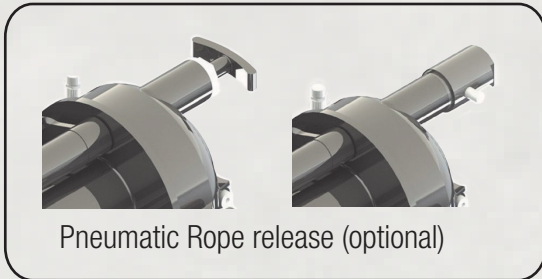

Rope Winding Count	Pulling Capacity lbs	Winding Speed ft-min	Rope Length ft
1	18000	27	19
2	14645	31	41
3	12301	35	66
4	10604	38	94
5	9318	41	131

Maximum Pulling Force	18000 lbs
Maximum Rope Diameter	3/9"
Maximum Pump Flow	15.8 gpm
Maximum Operating Pressure	2175 psi
Recommended Gear Oil Product	80w 90 - 27 fl oz
Weight	187 lbs
Maximum Rope Length	131 ft
Hydromotor	24 in ³
Gear Ratio	6/1