

TCF-30 Hydraulic Cooling Fan

Max Flow (GPM)	Capacity (kcal/h)
37	20000

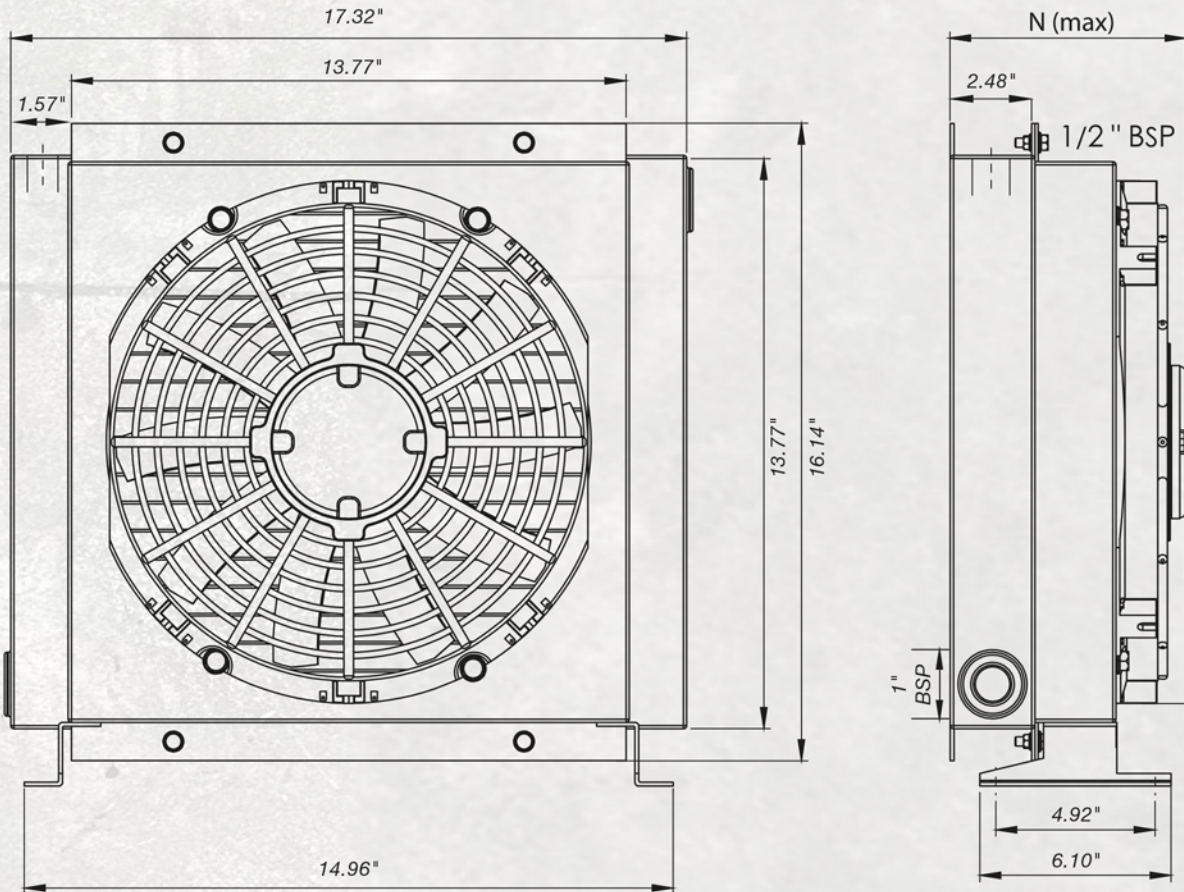

Voltage	Fan Diameter	Fan Speed (RPM)	dB(A) 1M	Power (HP)	Operation Pressure (PSI)	N (Max)
12 & 24	11.41"	2700	74	0.24	362	7.36"
230 & 400	11.81"	2800	72	0.25	362	9.52"