

THW-40K

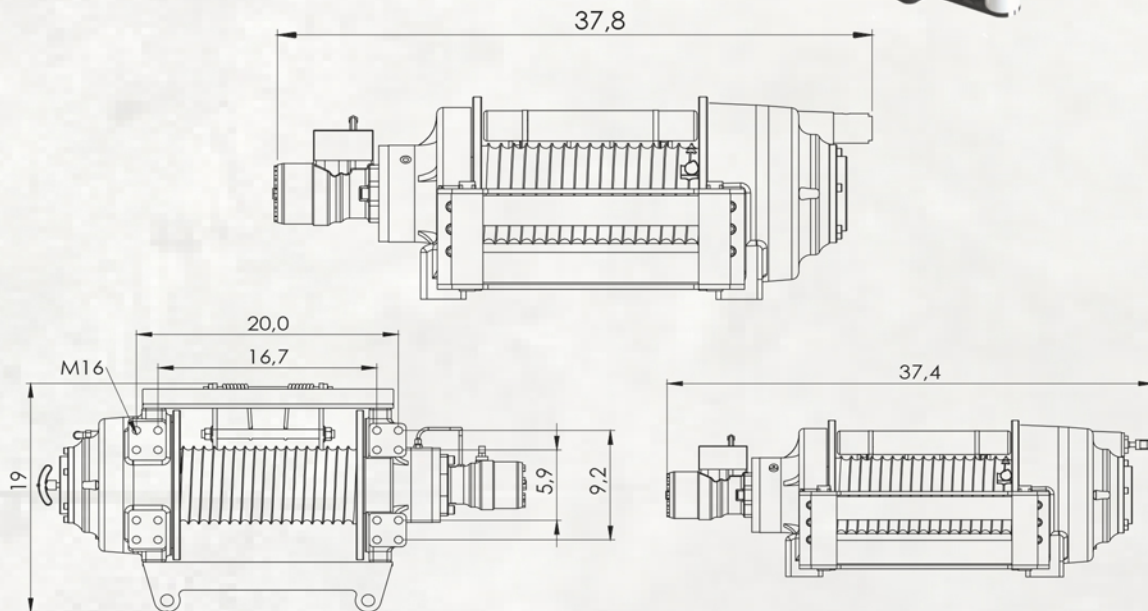
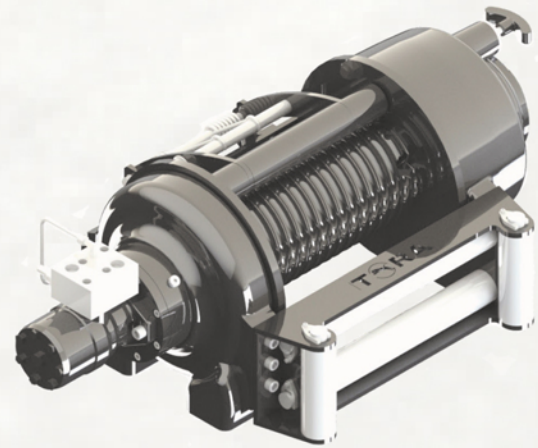
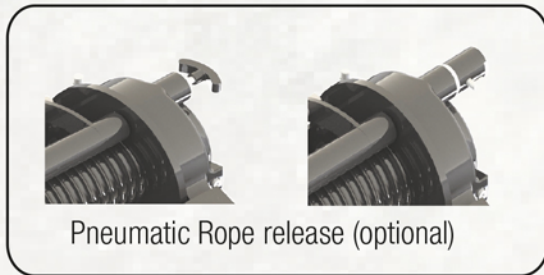

Rope Winding Count	Pulling Capacity lbs	Winding Speed ft-min	Rope Length ft
1	40000	14	24
2	32716	15	55
3	27809	17	91
4	14180	19	137

Maximum Pulling Force	40000 lbs
Maximum Rope Diameter	45/64"
Maximum Pump Flow	15.8 gpm
Maximum Operating Pressure	2393 psi
Recommended Gear Oil Product	80w 90 - 68 fl oz
Weight	441 lbs
Maximum Rope Length	137 ft
Hydromotor	12 in ³
Gear Ratio	36/1